

Article number: 03485030  
 Description: Fluro Rod end EIL 30D-2RS  
 Note: 30

## Measures

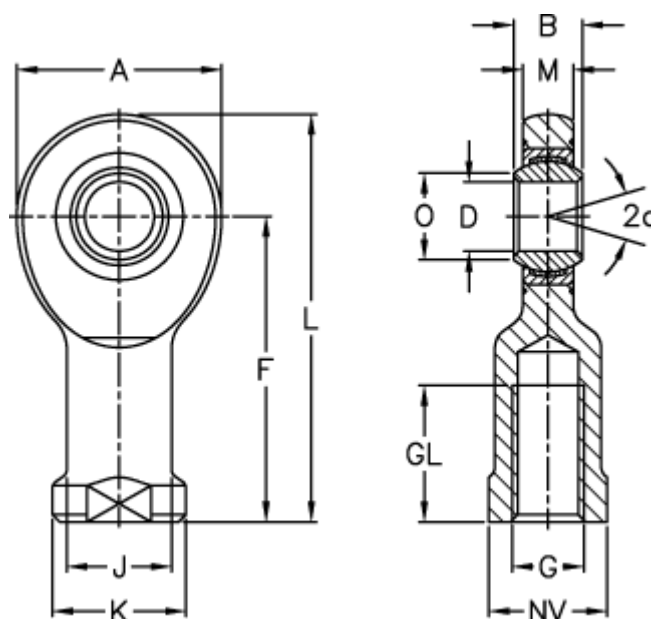

A	= 73	J	= 40
a (degrees)	= 6	K	= 50
B	= 22	L	= 146.5
D	= 30	M	= 19
Dynamic drive (kN)	= 66	NV	= 41
F	= 110	O	= 34.2
g	= M30x2	Static drive kN	= 124
GL	= 56	Weight	= 930